

Before using your air conditioner, please read
this manual carefully and keep it for future reference.

SPLIT-TYPE ROOM AIR CONDITIONER

INSTALLATION MANUAL

The design and specifications are subject to change without prior notice for
product improvement. Consult with the sales agency or manufacturer for details.

CS317I-AB
202000192688
20141114

- Please read this installation manual completely before installing the product.
- If the power cord is damaged, replacement work shall be performed by authorised personnel only.
- Installation work must be performed in accordance with the national wiring Standards by authorised personnel only.
- Contact an authorised service technician for repair, maintenance or installation of this unit.

CONTENTS

SAFETY PRECAUTIONS

Warning	2
Caution	2

INSTALLATION INSTRUCTIONS

Selecting installation place.....	3
Accessories	3
Indoor & outdoor unit installation drawings	4

INDOOR UNIT INSTALLATION

Installation plate mounting.....	5
Drill a hole in the wall	6
Connective pipe installation	6
Drain piping.....	7
Connect the cable to the indoor unit.....	7
Indoor unit installation.....	9

OUTDOOR UNIT INSTALLATION

Outdoor installation precaution	9
Settlement of outdoor unit	10
Drain joint installation	10
Refrigerant pipe connection	10
Connect the cable to the outdoor unit	12
Air purging.....	12

TEST RUNNING

Test running	14
--------------------	----



CAUTION

- Contact an authorised service technician for repair or maintenance of this unit.
- The appliance shall be installed in accordance with national wiring regulations.
- This appliance is not intended for use by persons (including children) with reduced physical, sensory or mental capabilities, or lack of experience and knowledge, unless they have been given supervision or instruction concerning use of the appliance by a person responsible for their safety.
- Young children should be supervised to ensure that they do not play with the air conditioner.
- Do not operate your air conditioner in a wet room such as a bathroom or laundry room.
- Installation work must be performed in accordance with the national wiring standards by authorised personnel only.

SAFETY PRECAUTIONS

- Read the follow SAFETY PRECAUTIONS carefully before installation.
- Incorrect installation due to ignoring of the instruction will cause harm or damage, and the seriousness is classified by the following indications.

	WARNING	This symbol indicates the possibility of death or serious injury.
	CAUTION	This symbol indicates the possibility of injury or damage to property.

The items to be followed are classified by the symbols:

	Symbol with background white denotes item that is PROHIBITED from doing.
--	--

WARNING

- 1) Engage dealer or specialist for installation. If installation done by the user is defective, it will cause water leakage, electrical shock or fire.
- 2) Install according to this installation instructions strictly. If installation is defective, it will cause water leakage, electrical shock or fire.
- 3) Use the attached accessories parts and specified parts for installation. otherwise, it will cause the set to fall, water leakage, electrical shock or fire.
- 4) Install at a strong and firm location which is able to withstand the set's weight. If the strength is not enough or installation is not properly done, the set will drop and cause injury.
- 5) For electrical work, follow the local national wiring standard, regulation and this installation instructions. An independent circuit and single outlet must be used. If electrical circuit capacity is not enough or defect found in electrical work, it will cause electrical shock or fire.
- 6) Use the specified cable and connect tightly and clamp the cable so that no external force will be acted on the terminal. If connection or fixing is not perfect, it will cause heat-up or fire at the connection.
- 7) Wiring routing must be properly arranged so that control board cover is fixed properly. If control board cover is not fixed perfectly, it will cause heat-up at connection point of terminal, fire or electrical shock.
- 8) When carrying out piping connection, take care not to let air substances other than the specified refrigerant go into refrigeration cycle. Otherwise, it will cause lower capacity, abnormal high pressure in the refrigeration cycle, explosion and injury.
- 9) Do not modify the length of the power supply cord or use of extension cord, and do not share the single outlet with other electrical appliances. Otherwise, it will cause fire or electrical shock.

CAUTION

- 1) This equipment must be earthed and installed with earth leakage current breaker. It may cause electrical shock if grounding is not perfect.
- 2) Do not install the unit at place where leakage of flammable gas may occur. In case gas leaks and accumulates at surrounding of the unit, it may cause fire.
- 3) Carry out drainage piping as mentioned in installation instructions. If drainage is not perfect, water may enter the room and damage the furniture.
- 4) For the unit adopts auxiliary electric heater, keep at least 1 meter away from the nearest combustible materials.

INSTALLATION INSTRUCTIONS

Selecting installation place

Read completely, then follow step by step.

Indoor unit

- There should not be any heat source, inflammable gas or stream near the unit.
- There should not be any obstacles blocking the air circulation.
- A place where air circulation in the room is good.
- A place where drainage can be easily done.
- A place where noise prevention is taken into consideration.
- Do not install the unit near the door way.
- Ensure the restrictions on installation specified in the indoor unit installation drawings are met.
- Select a location which is firm enough for installation so that the device is not subjected to vibrations.
- The device should be installed at a distance of at least 1m from all other electrical devices and installations, e.g. TV, radio, computer, etc.
- There should not be any direct sunlight. If unavoidable, sunlight prevention should be taken into consideration.

Outdoor unit

- If an awning is built over the unit to prevent direct sunlight or rain, be careful that heat radiation from the condenser is not obstructed.
- There should not be any animal or plant which could be affected by hot air discharged.
- Make sure that there is sufficient space as specified in the installation drawings.
- Do not place any obstacles which may cause a short circuit of the discharged air.
- Select a location which avoids causing a nuisance to neighbours from noise and air emissions from device.
- Select a location which is sufficiently well ventilated.
- Never cover the air inlets and outlets.
- The location must be sufficiently firm for installation and the prevention of vibrations.
- There must be no risk presented by combustible gas or gas escaping as a result of corrosion.
- Avoid a location where there is a high salt content.
- Avoid a location which is heavily exposed to dust.
- Avoid a location to which the general public have access.

Accessories

Indoor unit				
(A) Installation plate	1	(H) Air freshening filter (used to install on Air filter)	1	
(B) Clip Anchor	5			
(C) Mounting plate fixing screw ST3.9x25	5	(I) Seal	1 (for cooling & heating model only)	
(D) Remote controller	1	(J) Drain joint		
(E) Fixing screw for remote controller holder ST2.9X10	2	optional parts	(K) Owner's manual	1
(F) Remote controller holder	1		(L) Installation manual	1
(G) Dry battery AAA.LR03	2	(M) Remote controller illustration	1	

NOTE: Use the supplied installation accessories as required. The items necessary to install this air conditioner are not included must be purchased separately.

INSTALLATION INSTRUCTIONS

Indoor & outdoor unit installation drawings

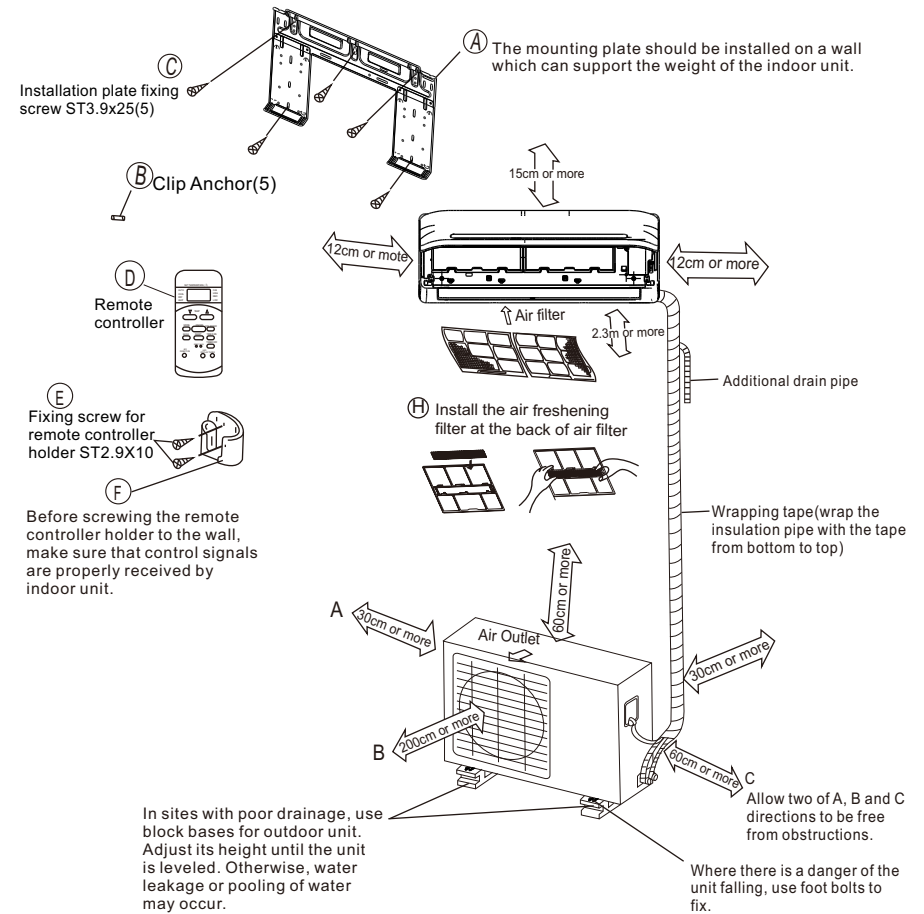

Fig.1

NOTE: Appearance of outdoor unit and indoor unit may differ from some models. The actual shape shall prevail.

INDOOR UNIT INSTALLATION

INDOOR UNIT INSTALLATION

Remove the installation plate from the indoor unit. The installation plate should be installed on a wall which can support the weight of the indoor unit.

1. Installation Plate Mounting

1. Fit the installation plate horizontally on structural parts of the wall with spaces around the installation plate.
2. If the wall is made of brick, concrete or the like, drill five 5mm diameter holes in the wall and insert Clip anchor for appropriate mounting screws.
3. Secure the installation plate to the wall with screws.

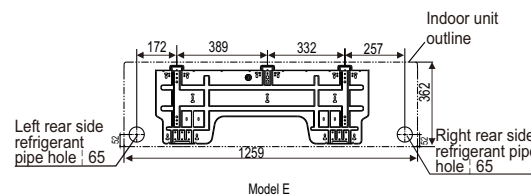
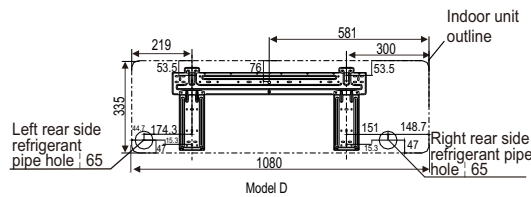
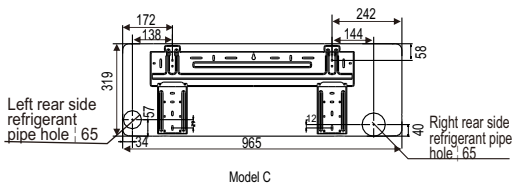
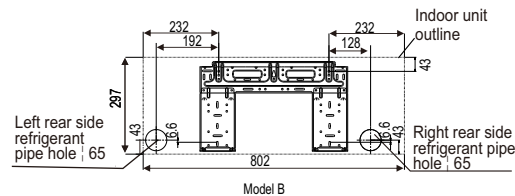
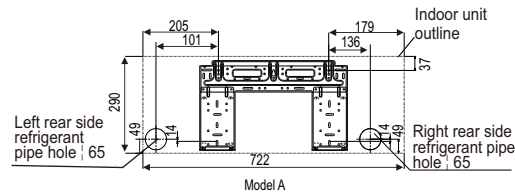

Fig.2

5

NOTE:

Mount the Installation Plate and drill holes in the wall according to the wall structure and corresponding mounting points on the installation plate. The installation plate provided with the machine differ from appliance to appliance.

(Dimensions are in " mm " unless otherwise stated)

The installation plate is fixed with a screw for the convenience of shipment, please remove the screw first before installation.

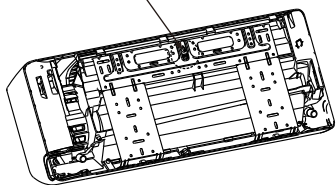

INDOOR UNIT INSTALLATION

2. Drill a hole in the wall

1. Determine hole positions according to left and right side of the installation plate. The hole center is obtained by measuring the distance as shown in the diagram of Fig.2.
2. Drill the piping plate hole with ϕ 65mm hole-core drill.
3. Drill the piping hole at either the right or the left and the hole should be slightly slanted to the outdoor side, so that the outside end is lower than inside end, see Fig.3.
4. Always take steps to protect the pipe when drilling metal grid, metal plate or the like.

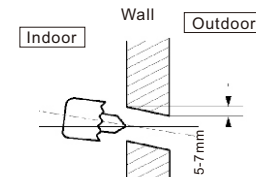

Fig.3

3. Connective pipe installation

1. For the left-hand and right-hand piping, remove the pipe cover from the side panel.
2. For the right back and left back piping, install the piping as shown.

NOTE: Both sides drainage structure is standard. For both sides drainage structure, it can be chosen for right, left or both sides drainage connection. If choosing both sides drainage connection, another proper drain hose is needed as there is only one drain hose offered by factory. If choosing one side drainage connection, make sure the drain hole on the other side is well plugged.

For 9k/12k models, if choosing left-hand or left-back piping, please choosing left side drainage connection. The connection of the drain hose is supposed to be done by qualified installer in case of water leakage.

3. Attach the drain hose to the underside of the refrigerant pipes with adhesive vinyl tape.
4. Wrap the refrigerant pipes and drain hose together with insulation tape.
5. Open the front panel, then open the wire cover, connecting the cables.
6. Bundle the pipes, connecting cable, and drain hose with tape securely, evenly as shown in Figure on the right.
7. Pass them through the wall hole.

- Because the condensed water from rear of the indoor unit is gathered in ponding box and is piped out of room. Do not put anything else in the box.

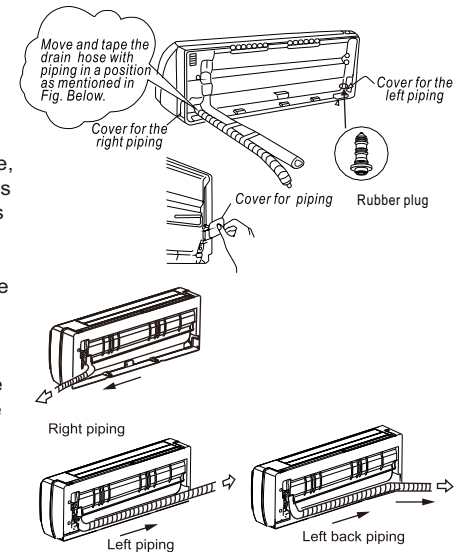

Fig.4

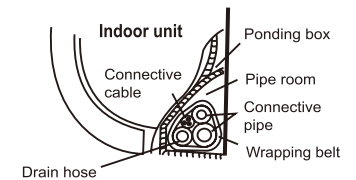

Fig.5

6

INDOOR UNIT INSTALLATION

CAUTION

- Connect the indoor unit first, then the outdoor unit.
- Do not allow the piping to let out from the back of the indoor unit.
- Be careful not to let the drain hose slack.
- Heat insulation should be done to the extension drain hose of indoor unit.
- Be sure that the drain hose is located at the lowest side of the bundle. Locating at the upper side can cause drain pan to overflow inside the unit.
- Never intercross nor intertwist the power wire with any other wiring.

4. Drain piping

1. Connect the drain hose as described in Fig.6. The drain hose should be inclined downward.
2. When drain hose requires extension, obtain an extension hose commercially available. Be sure to thermally insulate the indoor section of the extension hose. Do not let the drain hose slack.
3. Remove the air filter and pour some water into the drain pan to check the water flows smoothly.

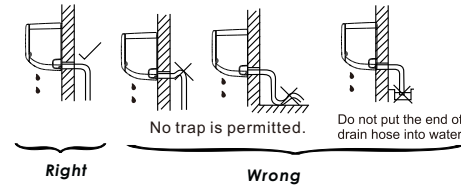

Fig.6

5. Connect the cable to the indoor unit

Electrical work

Electric safety regulations for the initial Installation

1. If there is serious safety problem about the power supply, the technicians should refuse to install the air conditioner and explain to the client until the problem is solved.
2. Power voltage should be in the range of 90%~110% of rated voltage.
3. The surge protector and main power switch with a 1.5 times capacity of Max. Current of the unit should be installed in power circuit. Ensure the air conditioner is grounded well.
4. The appliance shall be installed in accordance with national wiring regulations. Do not operate your air conditioner in a wet room such as a bathroom or laundry room.
5. An all-pole disconnection device which has at least 3mm clearances in all poles, and have a leakage current that may exceed 10mA, the residual current device(RCD) having a rated residual operating current not exceeding 30mA, and disconnection must be incorporated in the fixed wiring in accordance with the wiring rules.
6. For the unit adopts auxiliary electric heater, keep at least 1 meter away from the nearest combustible materials.
7. According to the attached Electrical Connection Diagram located on the panel of the indoor & outdoor unit to connect the wire.
8. All wiring must comply with local and national electrical codes and be installed by qualified and skilled electricians.
9. Every wire must be connected firmly. No wire should be allowed to touch refrigerant tubing, the compressor, or any moving parts.
10. Loose wiring may cause the terminal to overheat or result in unit malfunction. A fire hazard may also exist. Therefore, be sure all wiring is tightly connected.
9. An individual branch circuit and single receptacle used only for this air conditioner must be available. See the following table for suggested wire sizes and fuse specifications:

INDOOR UNIT INSTALLATION

Minimum cross-sectional area of conductors:

Rated current of appliance (A)	Nominal cross-sectional area (mm ²)
>3 and 6	0.75
>6 and 10	1
>10 and 16	1.5
>16 and 25	2.5
>25 and 32	4
>32 and 40	6

NOTE:

- The wire size of power supply cord and interconnected wire and the current of the fuse or switch are determined by the maximum current indicated on the nameplate which located on the side panel of the unit. Please refer to the nameplate before selecting the wire size, fuse or switch.
- The controller of the air conditioner designed with a fuse protection function under abnormal conditions, the specifications of the fuse have printed on the circuit board, such as: T3.15A/250VAC, T5A/250VAC, etc.

Connect the cable to the indoor unit

NOTE: Before performing any electrical work, turn off the main power to the system.

1. The indoor power cord type is H05VV-F or H05V2V2-F, the outdoor power cord and interconnected cord type is H07RN-F.
2. Lift the indoor unit panel up, remove the wire box cover by loosening the screw.
3. Remove the cable clamp. Match wire colours with terminal numbers on indoor and outdoor unit's terminal blocks and firmly screw wires to the corresponding terminals.
4. Connect the end of the connection cable fully inserting into the terminal block.
5. Fasten the connection cable with a cable clamp.

NOTE: The wiring connection is differ from appliance to appliance.

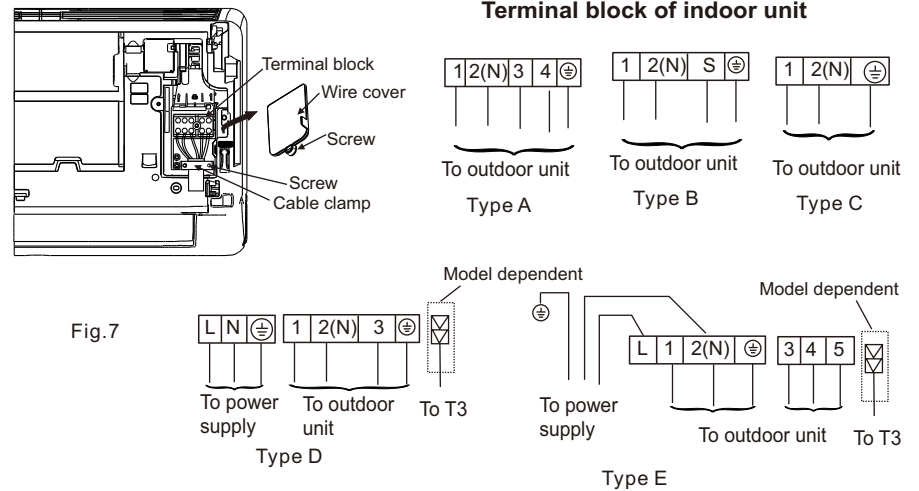
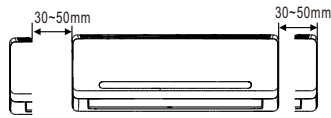

Fig.7

OUTDOOR UNIT INSTALLATION

Indoor unit installation

1. Pass the piping through the hole in the wall.
2. Hook the indoor unit onto the upper portion of installation plate (Engage the indoor unit with the upper edge of the installation plate). Ensure the hooks are properly seated on the installation plate by moving it in left and right.
3. Piping can easily be made by lifting the indoor unit with a cushioning material between the indoor unit and the wall. Get it out after finish piping. When use a wall embedded pipe, the indoor unit can be moved to the left or right for 30~50mm (model dependent), which offers sufficient space to arrange the pipes and ensure the indoor unit fully close to the wall after installation.
4. Press the lower left and right side of the unit against the installation plate until hooks engage with their slots.



Move to left or right

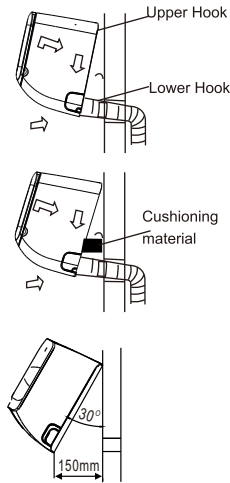

Wall embedded pipe

Fig.8

OUTDOOR UNIT INSTALLATION

Outdoor installation precaution

- Install the outdoor unit on a rigid base to prevent increasing noise level and vibration.
- Determine the air outlet direction where the discharged air is not blocked.
- In the case that the installation place is exposed to strong wind such as a seaside, make sure the fan operating properly by putting the unit lengthwise along the wall or using a dust or shield plates. Specially in windy area, install the unit to prevent the admission of wind. If need suspending installation, the installation bracket should accord with technique requirement in the installation bracket diagram.
- The installation wall should be solid brick, concrete or the same intensity construction, or actions to reinforce, damping supporting should be taken. The connection between bracket and wall, bracket and the air conditioner should be firm, stable and reliable.
- Be sure there is no obstacle which block radiating air.

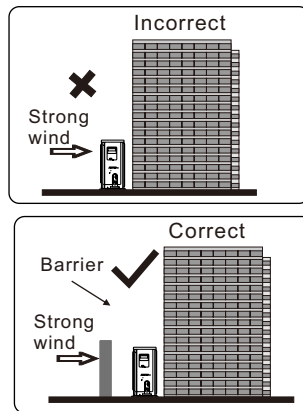

Fig.9

OUTDOOR UNIT INSTALLATION

Settlement of outdoor unit

- Anchor the outdoor unit with a bolt and nut | 10 or | 8 tightly and horizontally on a concrete or rigid mount. **NOTE:** The outdoor unit you purchase may be like one of the following. Install the outdoor unit according to the dimension as indicated in the table below:

Outdoor unit dimension mm(WxHxD)	Mounting dimensions	
	A(mm)	B(mm)
670x540x265	481	276
685x430x260	460	276
700x540x240	458	250
780x540x250	549	276
760x590x285	530	290
845x700x320	560	335
900x860x315	590	333
945x810x395	640	405
900x1170x350	590	378

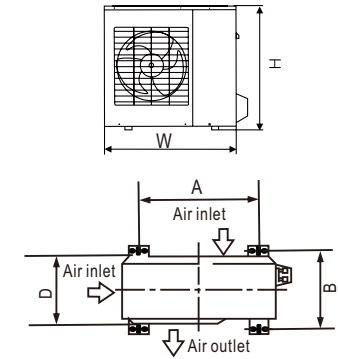

Fig.10

Drain joint installation

NOTE: The drain joint is slightly different according to the different outdoor unit. For the drain joint with the seal (Fig.11 (A)), first fit the seal onto the drain joint, then insert the drain joint into the base pan hole of outdoor unit, rotate 90 to securely assemble them. To install drain joint as shown in Fig.11 (B), insert the drain joint into the base pan hole of outdoor unit until it remains fixed with a clicking sound. Connecting the drain joint with an extension drain hose (Locally purchased), in case of the water draining off the outdoor unit during the heating mode.

NOTE: In cold areas, do not use a drain hose with the outdoor unit. (otherwise, drain water may freeze)

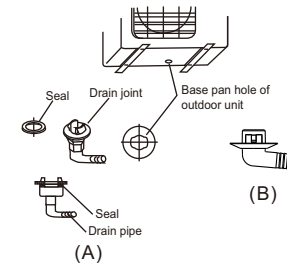

Fig.11

Refrigerant pipe connection

NOTE: Connective pipe length will affect the capacity and energy efficiency of the unit. The nominal efficiency is tested basing on the pipe length of 5 meters. Consult the technicians to purchase proper size connective pipe for your machine..

1. Flaring work

Main cause for refrigerant leakage is due to defect in the flaring work. Carry out correct flaring work using the following procedure:

A: Cut the pipes and the cable.

1. Use the piping kit accessory or pipes purchased locally.
2. Measure the distance between the indoor and the outdoor unit.
3. Cut the pipes a little longer than the measured distance.
4. Cut the cable 1.5m longer than the pipe length.

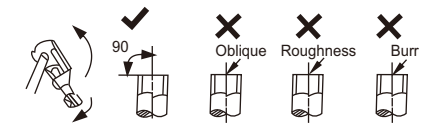

Fig.12

OUTDOOR UNIT INSTALLATION

B: Burr removal

1. Completely remove all burrs from the cut cross section of pipe/tube.
2. Put the end of the copper tube/pipe in a downward direction as you remove burrs in order to avoid dropping burrs into the tubing.

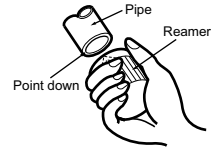

Fig. 13

C: Putting nut on

Remove flare nuts attached to indoor and outdoor unit, then put them on pipe/tube having completed burr removal. (not possible to put them on after flaring work)

D: Flaring work

Firmly hold copper pipe in a die in the dimension shown in the table below.

Outer diam. (mm)	A(mm)	
	Max.	Min.
φ 6.35	1.3	0.7
φ 9.52	1.6	1.0
φ 12.7	1.8	1.0
φ 16	2.2	2.0

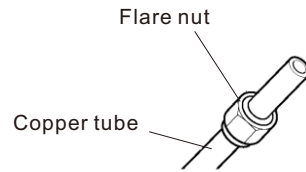

Fig. 14

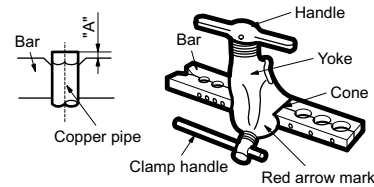

Fig. 15

2. Tightening Connection

- Align the center of the pipes.
- Sufficiently tighten the flare nut with fingers, and then tighten it with a spanner and torque wrench as shown in Fig.16 & 17.

Outer diam.	Tightening torque(N.cm)	Additional tightening torque(N.cm)
φ 6.35	1500 (153kgf.cm)	1600 (163kgf.cm)
φ 9.52	2500 (255kgf.cm)	2600 (265kgf.cm)
φ 12.7	3500 (357kgf.cm)	3600 (367kgf.cm)
φ 16	4500 (459kgf.cm)	4700 (479kgf.cm)

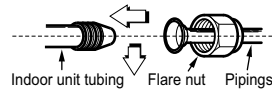

Fig. 16

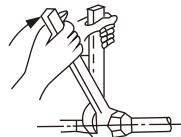

Fig. 17

Caution

- Excessive torque can break nut depending on installation conditions.

OUTDOOR UNIT INSTALLATION

Connect the cable to the outdoor unit

1. Remove the electrical wiring cover from the outdoor unit by loosening the screws.
2. Connect the connective cables to the terminals as identified with their respective matched numbers on the terminal block of indoor and outdoor units.
3. Secure the cable onto the control board with the cable clamp.
4. To prevent the ingress of water, form a loop of the connective cable as illustrated in the installation drawings of indoor and outdoor units.
5. Insulate unused cords (conductors) with PVC-tape. Process them so they do not touch any electrical or metal parts.

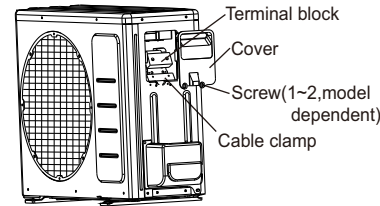
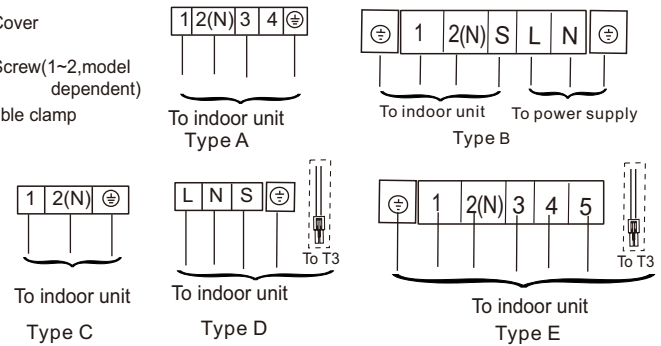

Fig. 18

Terminal block of outdoor unit



Air purging

Air and other foreign matter in the refrigerant circuit causes abnormal pressure rise, which may result in equipment damage and even injury. Therefore, the indoor unit and tubing between the indoor and outdoor unit must be leak tested and evacuated to remove any noncondensables and moisture from the system.

1. Air purging with vacuum pump

Preparation

Check that each tube(both liquid and gas side tubes) between the indoor and outdoor units have been properly connected and all wiring for the test run has been completed. Remove the service valve caps from both the gas and the liquid side on the outdoor unit. Note that both the liquid and the gas side service valves on the outdoor unit are kept closed at this stage.

Pipe length and refrigerant amount:

Connective pipe length	Air purging method	Additional amount of refrigerant to be charged	
Less than 5m	Use vacuum pump.	_____	
More than 5m	Use vacuum pump.	Liquid side: φ 6.35 R22: (Pipe length-5)x30g/m R410A: (Pipe length-5)x20g/m	Liquid side: φ 9.52 R22: (Pipe length-5)x60g/m R410A: (Pipe length-5)x40g/m

OUTDOOR UNIT INSTALLATION

- When relocate the unit to another place, perform evacuation using vacuum pump.
- Make sure the refrigerant added into the air conditioner is liquid form in any case. (Not applicable to the units adopt freon R22)

Caution in handling the packed valve

- Open the valve stem until it hits against the stopper. Do not try to open it further.
- Securely tighten the valve stem cap with a spanner or the like.
- Valve stem cap tightening torque (See Tightening torque table in previous page).

2. When Using the Vacuum Pump

(For method of using a manifold valve, refer to its operation manual.)

1. Completely tighten the flare nuts, A, B, C, D, connect the manifold valve charge hose to a charge port of the low-pressure valve on the gas pipe side.
2. Connect the charge hose connection to the vacuum pump.
3. Fully open the handle Lo of the manifold valve.
4. Operate the vacuum pump to evacuate. After starting evacuation, slightly loose the flare nut of the Lo valve on the gas pipe side and check that the air is entering (Operation noise of the vacuum pump changes and a compound meter indicates 0 instead of minus)
5. After the evacuation is complete, fully close the handle Lo of the manifold valve and stop the operation of the vacuum pump. Make evacuation for 15 minutes or more and check that the compound meter indicates -76cmHg ($-1 \times 10^5 \text{Pa}$).
6. Turn the stem of the packed valve B about 45° counterclockwise for 6~7 seconds after the gas coming out, then tighten the flare nut again. Make sure the pressure display in the pressure indicator is a little higher than the atmosphere pressure.
7. Remove the charge hose from the Low pressure charge hose.
8. Fully open the packed valve stems B and A.
9. Securely tighten the cap of the packed valve.

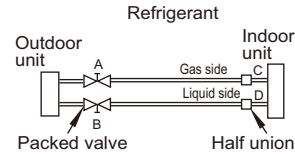

Fig.19

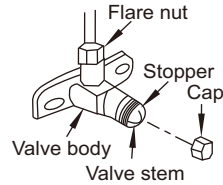

Fig.20

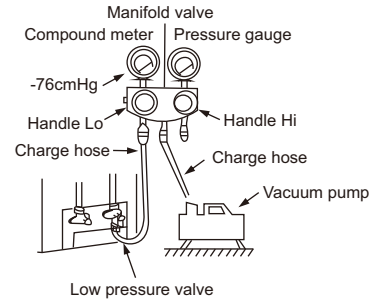

Fig.21

TEST RUNNING

3. Safety and leakage check

Electrical safety check

Perform the electric safe check after completing installation:

1. Grounding work

After finishing grounding work, measure the grounding resistance by visual detection and grounding resistance tester. Make sure the grounding resistance is less than 4Ω .

2. Electrical leakage check (performing during test running)

During test operation after finishing installation, the serviceman can use the electroprobe and multimeter to perform the electrical leakage check. Turn off the unit immediately if leakage happens. Check and find out the solution ways till the unit operate properly.

Gas leak check

1. Soap water method:

Apply a soap water or a liquid neutral detergent on the indoor unit connections and outdoor unit connections by a soft brush to check for leakage of the connecting points of the piping. If bubbles come out, it indicates that the pipes have leakage.

2. Leak detector

Use the leak detector to check for leakage.

CAUTION

A: Lo packed valve B: Hi packed valve

C and D are ends of indoor unit connection.

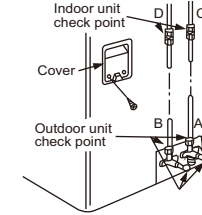
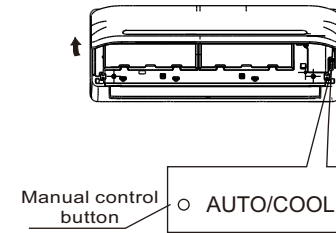

Fig.22

TEST RUNNING

Perform test operation after completing gas leak check at the flare nut connections and electrical safety check.

- Check that all tubing and wiring have been properly connected.
 - Check that the gas and liquid side service valves are fully open.
1. Connect the power, press the ON/OFF button on the remote controller to turn the unit on.
 2. Use the MODE button to select COOL, HEAT, AUTO and FAN to check if all the functions works well.
 3. When the ambient temperature is too low (lower than 17°C), the unit cannot be controlled by the remote controller to run at cooling mode, manual operation can be taken. Manual operation is used only when the remote controller is disable or maintenance necessary.
 - Hold the panel sides and lift the panel up to an angle until it remains fixed with a clicking sound.
 - Press the Manual control button to select the AUTO or COOL, the unit will operate under Forced AUTO or COOL mode (see User Manual for details).
 4. The test operation should last about 30 minutes.



14